

ConStandS

	DE - Montage- und Verwendungshinweise	2
	EN - Mounting and usage instructions	2
	FR - Instructions de montage et d'utilisation	4
	NL - Montage- en gebruiksinstructies	4
	IT - Istruzioni per il montaggio e l'uso	6
	ES - Instrucciones de montaje y uso	6
	PL - Montage- en gebruiksinstructies	8
	SE - Montage- en gebruiksinstructies	8
	DK - Instruktioner for montering og brug	10
	RO - Instrucțiuni de montare și utilizare	10
	Fi - Asennus- ja käyttöohjeet	12
	PT - Instruções de montagem e utilização	12
	CZ - Návod k montáži a použití	14
	HU - Szerelési és használati utasítások	14

ConStand's Power
304200



Allgemeine Hinweise

Vielen Dank für den Kauf eines ConStand's Zentralständers. Bitte lesen Sie sich die folgenden Montagehinweise sorgfältig durch. Die Motea GmbH übernimmt keine Haftung für Sach- und/oder Personenschäden, die durch eine unsachgemäße beziehungsweise mangelhafte Montage oder Nutzung entstehen.

Überprüfen Sie vor jedem Gebrauch die korrekte Funktionsweise. Ziehen Sie bei Bedarf die Schrauben nach.

Technische Änderungen, Druckfehler und Irrtümer vorbehalten.

General Information

Thank you for purchasing a ConStand's central stand.

Please read the following installation instructions carefully. Motea GmbH accepts no liability for damage to property and/or personal injury resulting from improper or faulty installation or use. Please check the correct function before each use. Retighten the screws if necessary.

Subject to technical changes, printing errors and mistakes.

Lieferumfang / Scope of delivery

1. Adapterplatte / Adapter plate (x 1)
2. Hubbolzen / Lifting bolt (x 1)
3. Hubhülse / Frame bushing (x 1)
4. Pin Schwingachse / Pin swing shaft (x 1)
5. Mutter / Nut (x 1)

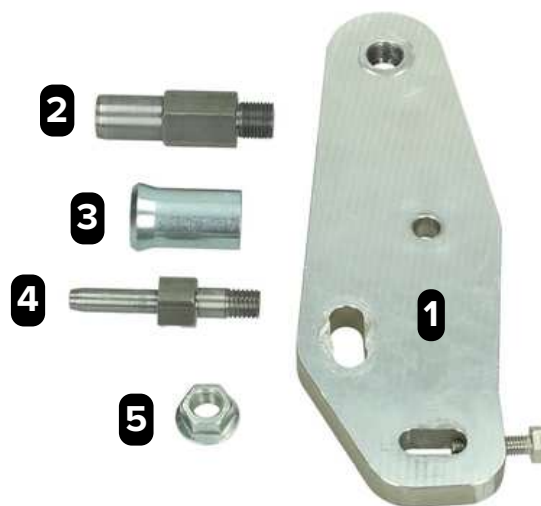

Montage Adapterplatte / Mounting of the adapter plate

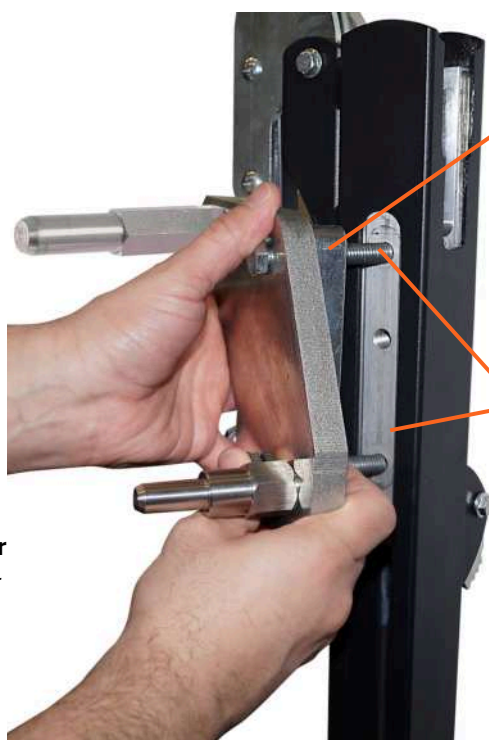

Distanzstück / Distance plate

303503



Nur für Power Classic erforderlich.
Only required for Power Classic.

Die Schrauben und Unterlegscheiben zur Befestigung der Adapterplatte am Zentralständer sind im Lieferumfang des Zentralständers enthalten.

The screws and washers for attaching the adapter plate to the center stand are included in the scope of delivery of the center stand.

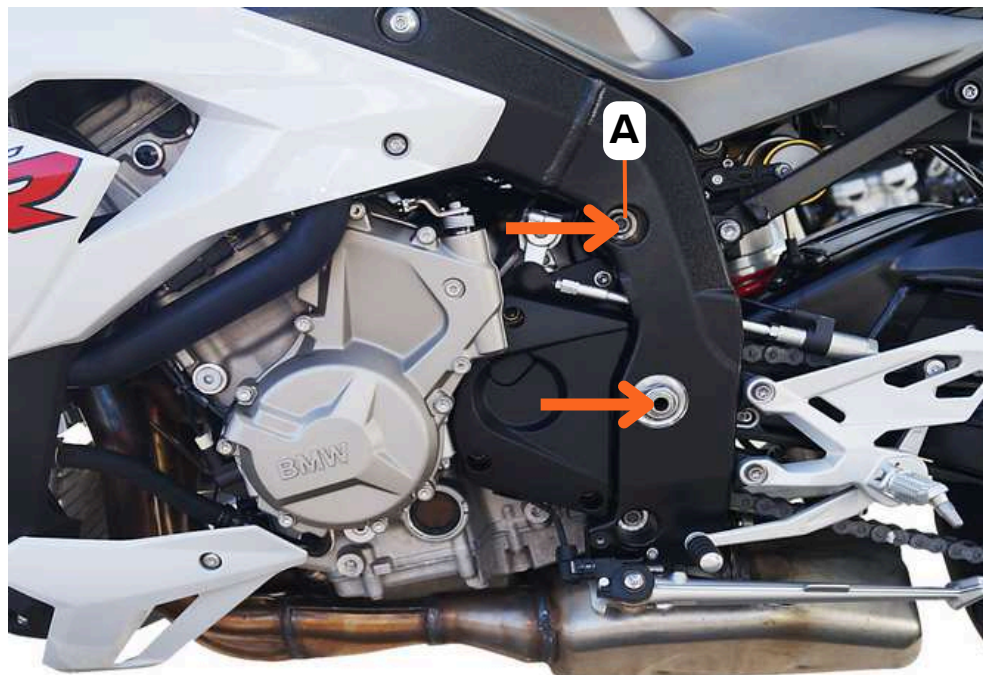

Montage am Fahrzeug / Mounting at the vehicle

1

Lösen Sie den Motorbolzen (A).

Loosen the motor bolt (A).

2

Verschrauben Sie den Motorbolzen (A) mit der Hubhülse (3).

Screw the motor bolt (A) to the frame bushing (3).

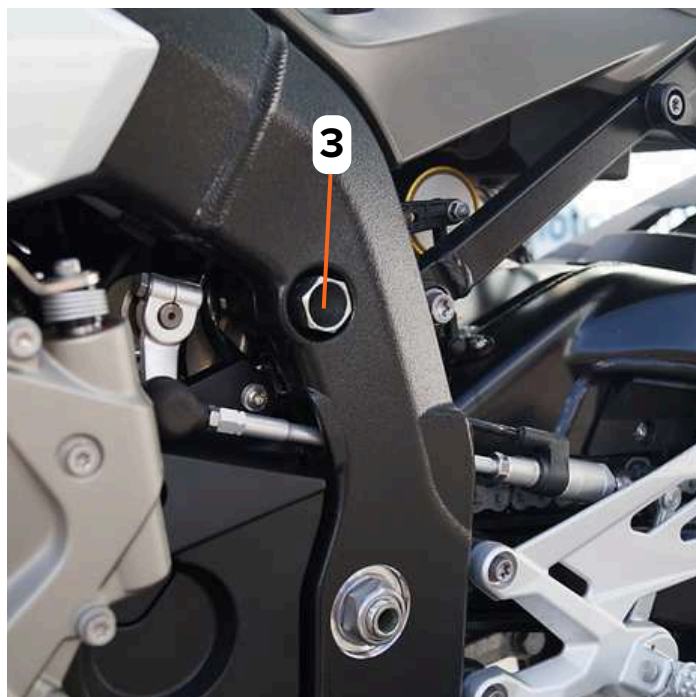
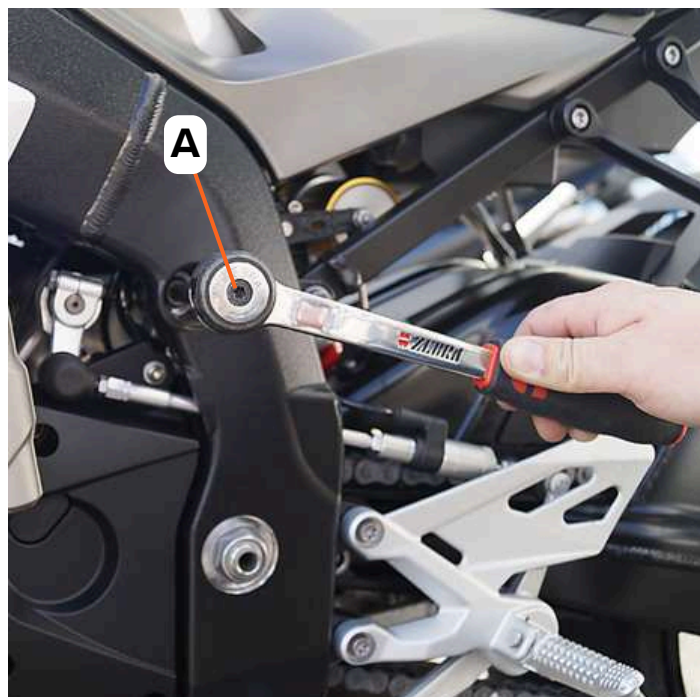

ConStands Power
304200



Informations générales

Nous vous remercions d'avoir acheté un stand central ConStands.

Veillez lire attentivement les instructions d'installation suivantes. Motea GmbH décline toute responsabilité en cas de dommages matériels et/ou corporels résultant d'une installation ou d'une utilisation incorrecte ou défectueuse. Veuillez vérifier le bon fonctionnement de l'appareil avant chaque utilisation. Resserrez les vis si nécessaire.

Sous réserve de modifications techniques, de fautes d'impression et d'erreurs.

Algemene informatie

Hartelijk dank voor de aanschaf van een ConStands middenstandaard.

Lees de volgende montage-instructies zorgvuldig door. Motea GmbH aanvaardt geen aansprakelijkheid voor schade aan eigendommen en/of persoonlijk letsel als gevolg van onjuiste of foutieve installatie of gebruik. Controleer voor elk gebruik de juiste werking. Draai de schroeven indien nodig opnieuw aan.

Technische wijzigingen, drukfouten en vergissingen voorbehouden.

Contenu de la livraison / Omvang van de levering

1. **Plaque d'adaptation / Adapterplaat (x 1)**
2. **Boulon de levage / Hefbout (x1)**
3. **Douille de cadre / Frame bus (x1)**
4. **Goupille arbre oscillant / Pen zwenkas (x1)**
5. **Écrou / Moer (x1)**

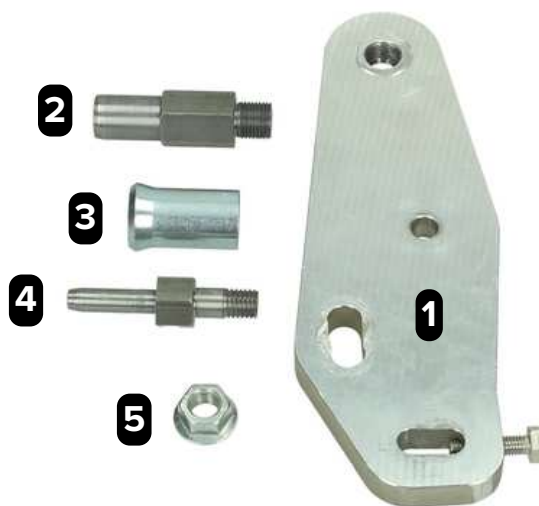

Montage de la plaque d'adaptation / Montage van de adapterplaat

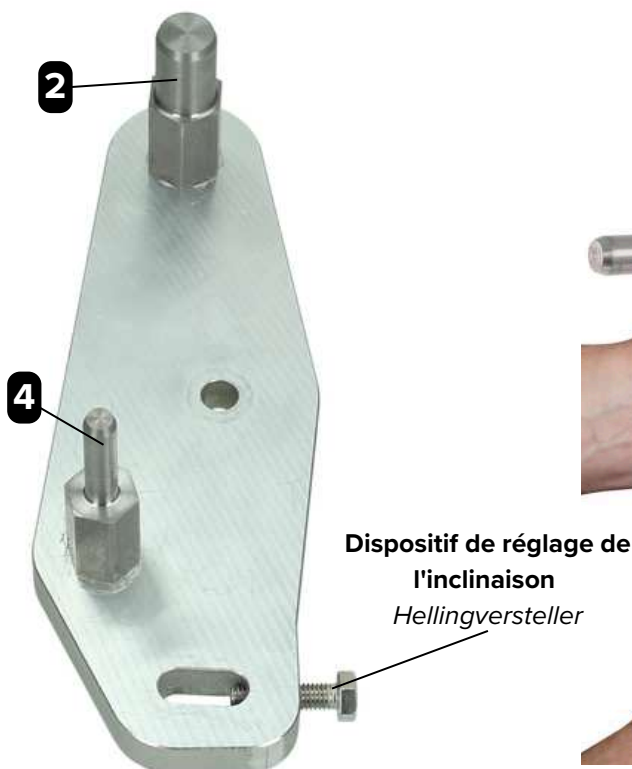

Plaque d'écartement / Afstandsplaat

303503

Nécessaire uniquement pour le Power Classic.

Alleen vereist voor Power Classic.

Les vis et les rondelles permettant de fixer la plaque d'adaptation à la béquille centrale sont incluses dans la livraison de la béquille centrale.

De schroeven en onderleggingen voor het bevestigen van de adapterplaat aan de middenstandaard worden meegeleverd met de middenstandaard.

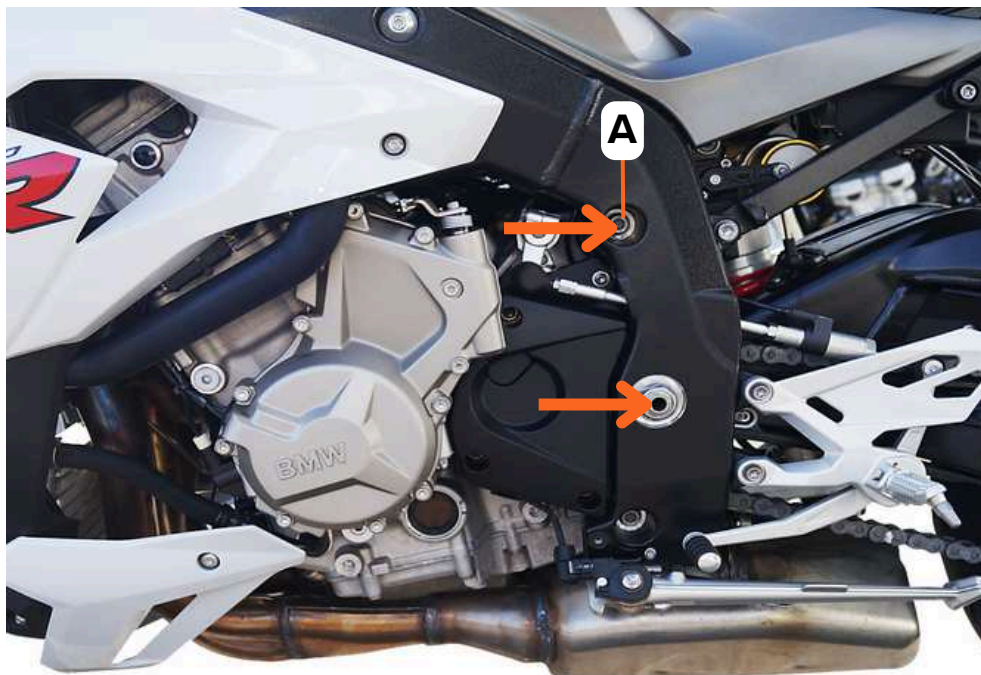

Montage sur le véhicule / Montage aan het voertuig

1

Desserrez le boulon du moteur (A).

Draai de motorbout (A) los.

2

Vissez le boulon du moteur (A) sur la bague du châssis (3).

Schroef de motorbout (A) op de framebus (3).

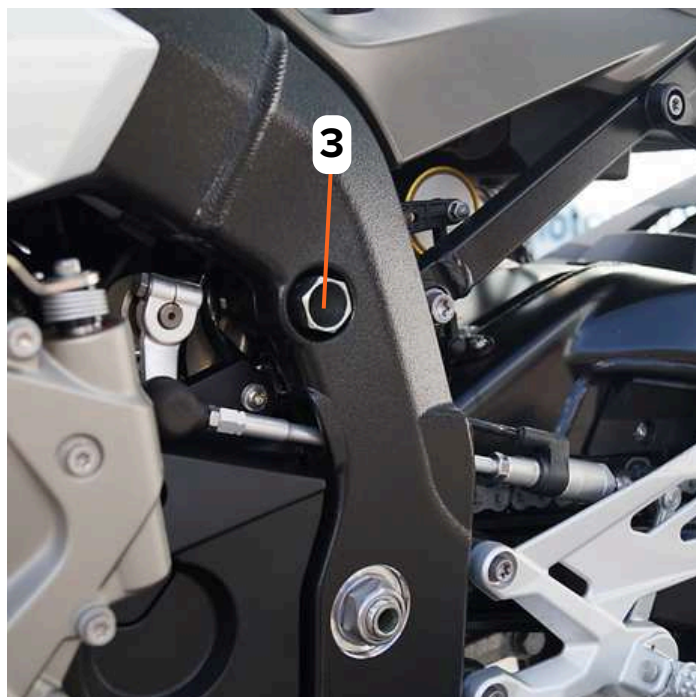

ConStands Power 304200



Informazioni generali

Grazie per aver acquistato un supporto centrale ConStands.

La preghiamo di leggere attentamente le seguenti istruzioni di montaggio. Motea GmbH non si assume alcuna responsabilità per danni a cose e/o persone derivanti da un'installazione o da un utilizzo improprio o errato. Verifichi il corretto funzionamento prima di ogni utilizzo. Se necessario, serri nuovamente le viti.

Con riserva di modifiche tecniche, errori di stampa ed errori.

Información general

Gracias por adquirir un caballete central ConStands.

Lea atentamente las siguientes instrucciones de instalación. Motea GmbH no se hace responsable de los daños materiales y/o personales que resulten de una instalación o uso incorrecto o defectuoso. Compruebe el correcto funcionamiento antes de cada uso. Vuelva a apretar los tornillos si es necesario.

Sujeto a cambios técnicos, errores de impresión y equivocaciones.

Ambito di consegna / Alcance de la entrega

1. **Piastra adattatore** / Placa adaptadora (x1)
2. **Bullone di sollevamento** / Perno de elevación (x1)
3. **Boccola del telaio** / Casquillo del bastidor (x1)
4. **Albero di rotazione del perno** / Pasador eje de giro (x1)
5. **Dado** / Tuerca (x1)

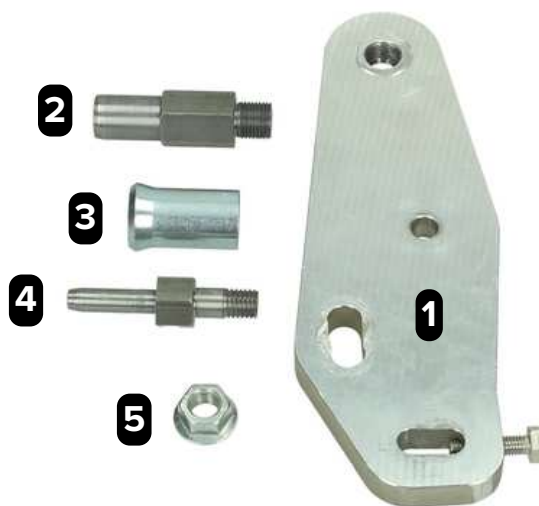

Montaggio della piastra di adattamento / Montaje de la placa adaptadora

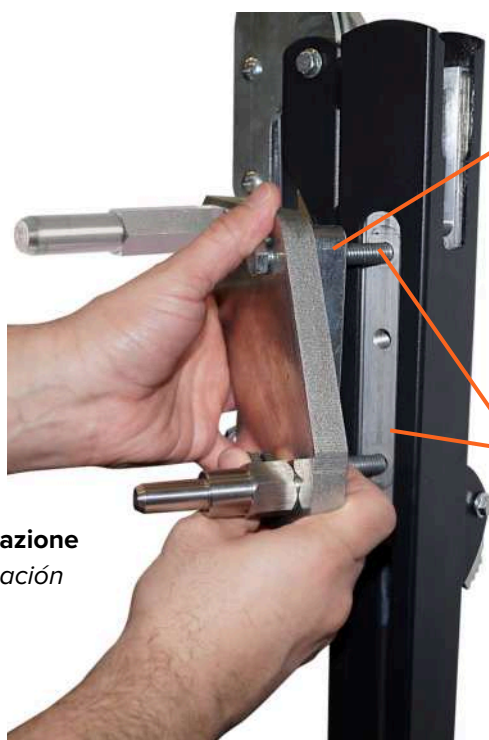

Piastra distanziatrice / Placa de distancia

303503

Necessario solo per Power Classic.
Solo necesario para Power Classic.



Le viti e le rondelle per il fissaggio della piastra di adattamento al cavalletto centrale sono incluse nella fornitura del cavalletto centrale.

Los tornillos y arandelas para fijar la placa adaptadora al caballete central están incluidos en el alcance de la entrega del caballete central.

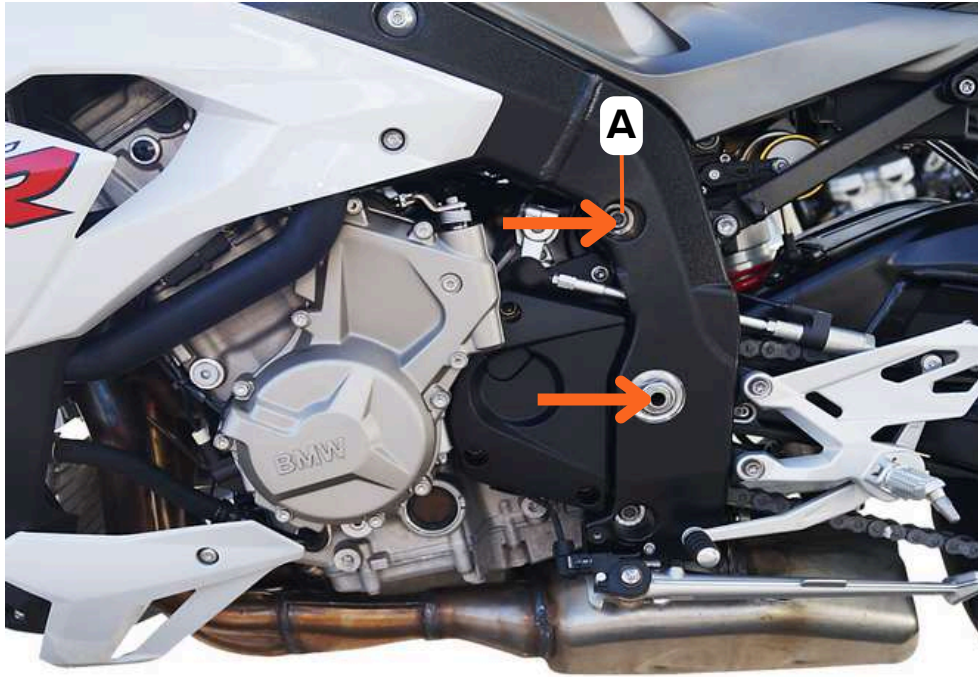

Montaggio sul veicolo / Montaje en el vehículo

1

Allenti il bullone del motore (A).

Afloje el perno del motor (A).

2

Avviti il bullone del motore (A) alla boccola del telaio (3).

Atornille el perno del motor (A) al casquillo del marco (3).

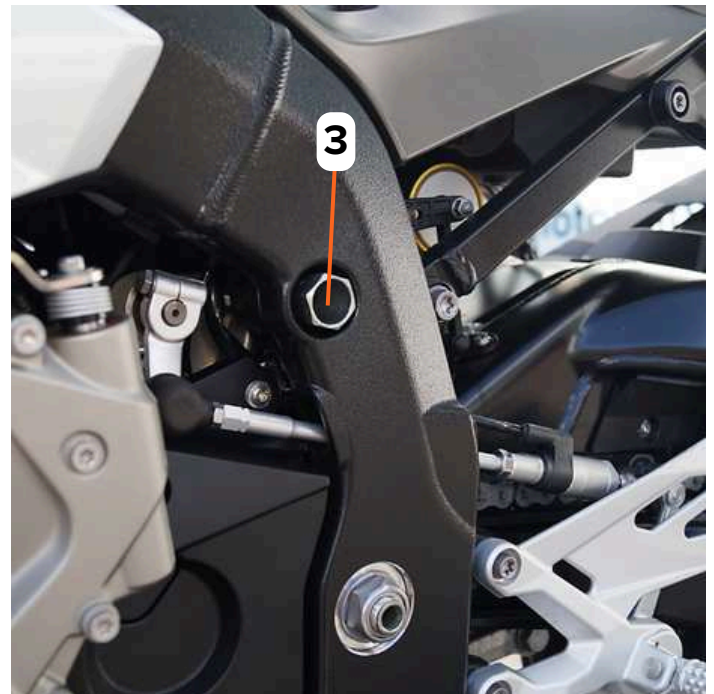

ConStands Power 304200



Informacje ogólne

Dziękujemy Państwu za zakup stojaka centralnego ConStands.

Proszę uważnie przeczytać poniższą instrukcję montażu. Motea GmbH nie ponosi odpowiedzialności za szkody materialne i/lub obrażenia ciała wynikające z niewłaściwej lub wadliwej instalacji lub użytkowania. Proszę sprawdzić poprawność działania przed każdym użyciem. W razie potrzeby proszę dokręcić śruby.

Zastrzega się prawo do zmian technicznych, błędów drukarskich i pomyłek.

Allmän information

Tack för att du har köpt ett ConStands centralstativ.

Läs följande installationsanvisningar noggrant. Motea GmbH tar inget ansvar för egendoms- och/eller personskador som uppstår på grund av felaktig eller bristfällig installation eller användning. Kontrollera att funktionen är korrekt före varje användningstillfälle. Dra åt skruvarna igen om det behövs.

Med reservation för tekniska ändringar, tryckfel och misstag.

Zakres dostawy / Omfattning av leveransen

1. Płyta adaptera / Adapterplatta (x 1)
2. Śruba podnosząca / Lyftbult (x1)
3. Tuleja ramy / Bussning för ram (x1)
4. Wałek wahliwy sworznia / Stift svängande axel (x1)
5. Nakrętka / Mutter (x1)

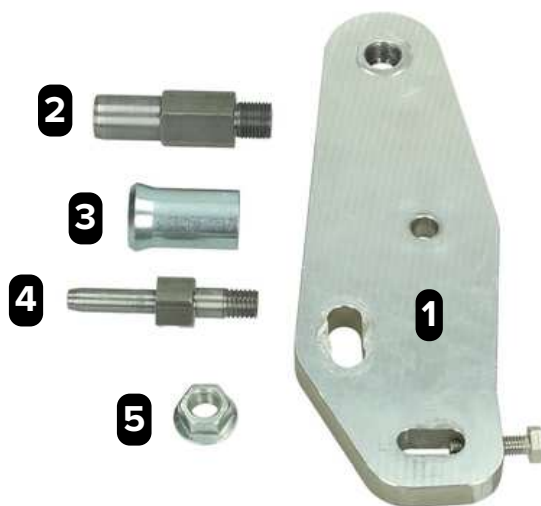

Montaż płyty adaptera / Montering av adapterplatta



Regulator nachylenia
Justerare för lutning

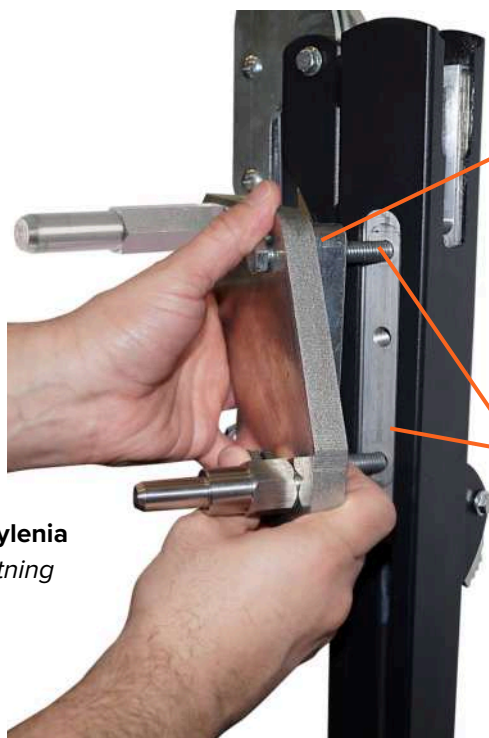

Płyta dystansowa / Avståndsplatta

303503

Wymagane tylko w przypadku Power Classic.

Krävs endast för Power Classic.

Śruby i podkładki do mocowania płyty adaptera do podpórki centralnej w zakres dostawy podpórki centralnej.

Skruvar och brickor för att fästa adapterplattan på mittstödet ingår i leveransomfattningen för mittstödet.

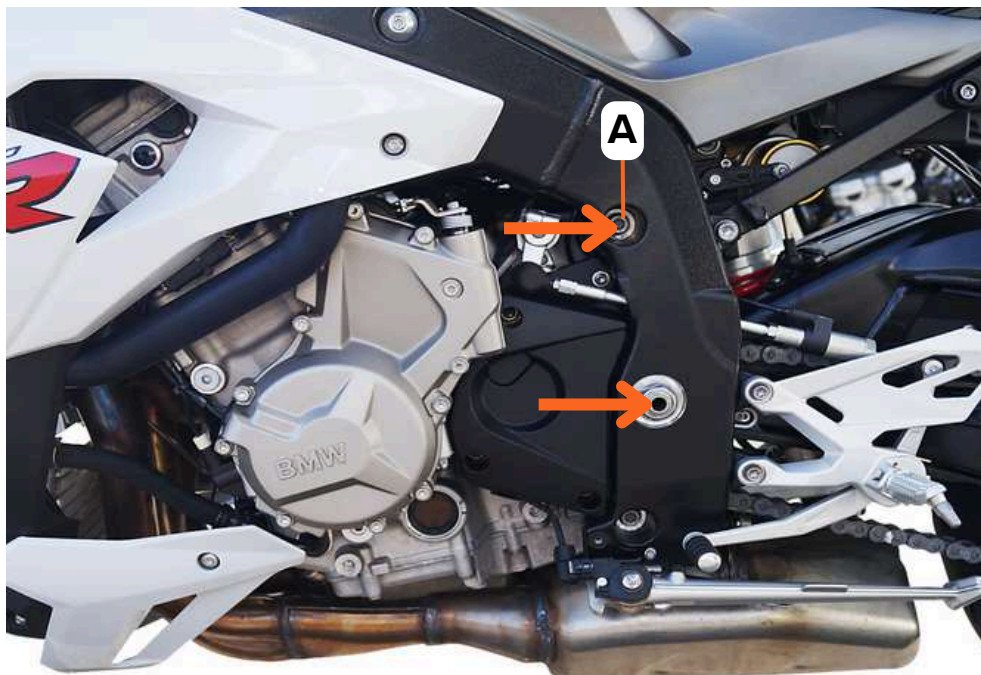

Montaż na pojeździe / Montering vid fordonet

1

Poluzować śrubę silnika (A).

Lösa motorbulten (A).

2

Przykręcić śrubę silnika (A) do tulei ramy (3).

Skruva fast motorbulten (A) på rambussningen (3).

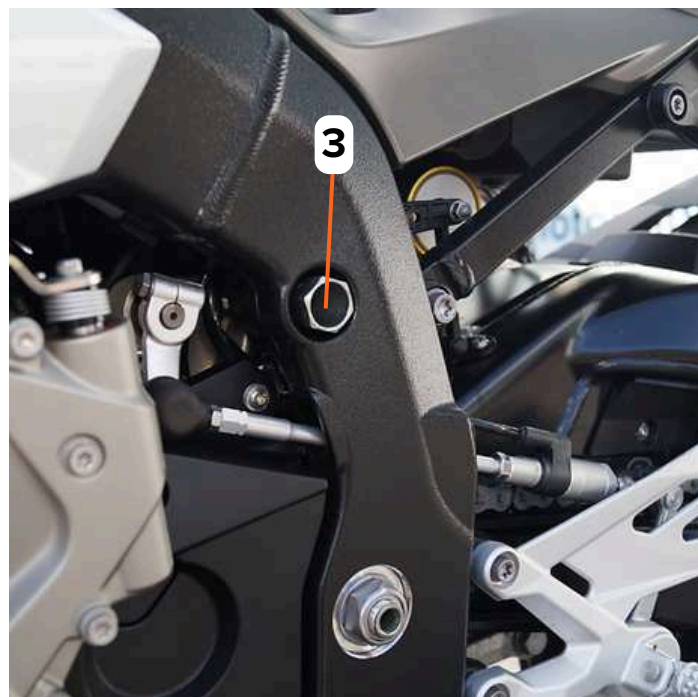

ConStands Power
304200



General information

Tak, fordi du har købt et ConStands centralstativ.

Læs venligst følgende monteringsvejledning omhyggeligt. Motea GmbH påtager sig intet ansvar for materielle skader og/eller personskader som følge af forkert eller mangelfuld installation eller brug. Kontroller den korrekte funktion før hver brug. Efterspænd skruerne, hvis det er nødvendigt.

Der tages forbehold for tekniske ændringer, trykfejl og fejl.

Informații generale

Vă mulțumim pentru achiziționarea unui suport central ConStands.

Vă rugăm să citiți cu atenție următoarele instrucțiuni de montaj. Motea GmbH nu acceptă nicio răspundere pentru daune materiale și/sau vătămări corporale rezultate în urma instalării sau utilizării necorespunzătoare sau defectuoase. Vă rugăm să verificați funcționarea corectă înainte de fiecare utilizare. Strângeți din nou șuruburile dacă este necesar.

Sub rezerva modificărilor tehnice, a erorilor de tipărire și a greșelilor.

Leveringsomfang / Domeniul de livrare

1. **Adapterplade** / Placă adaptoare (x1)
2. **Løftbolt** / Bolț de ridicare (x1)
3. **Ramme-bøsning** / Bucșă cadru (x1)
4. **Stift svingaksel** / Ax pivotant (x1)
5. **Møtrik** / Piuliță (x1)



Montering af adapterplade / Montarea plăcii adaptoare



Justering af hældning
Regulator de înclinare

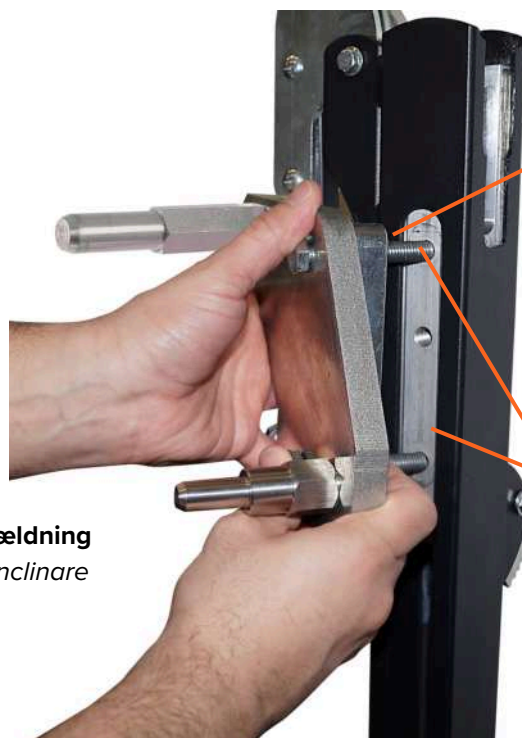

Afstandsplade /
Placă de distanțare

303503

Kræves kun til Power Classic.
Necesară numai pentru Power Classic.

Skruer og spændeskiver til fastgørelse af adapterpladen på midterstanderen er inkluderet i leveringsomfanget for midterstanderen.

Șuruburile și șaibele pentru fixarea plăcii adaptoare pe stativul central sunt incluse în pachetul de livrare al stativului central.

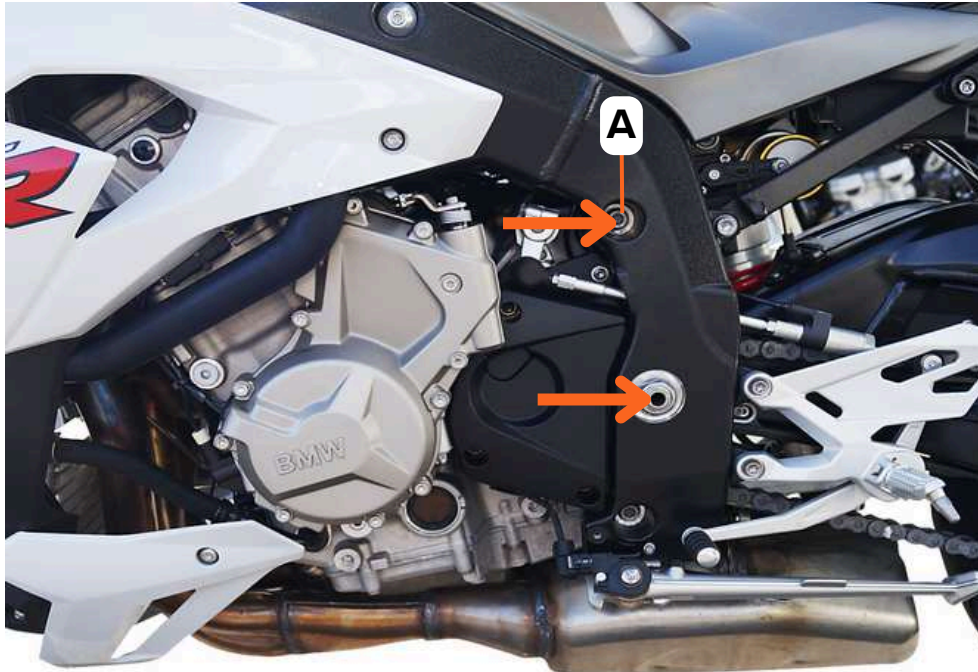

Montering ved køretøjet / Montarea la vehicul

1

Løsn motorbolten (A).

Slăbiți șurubul motorului (A).

2

Skru motorbolten (A) fast på rammebøsningen (3).

Înșurubați șurubul motorului (A) la bucașa cadrului (3).

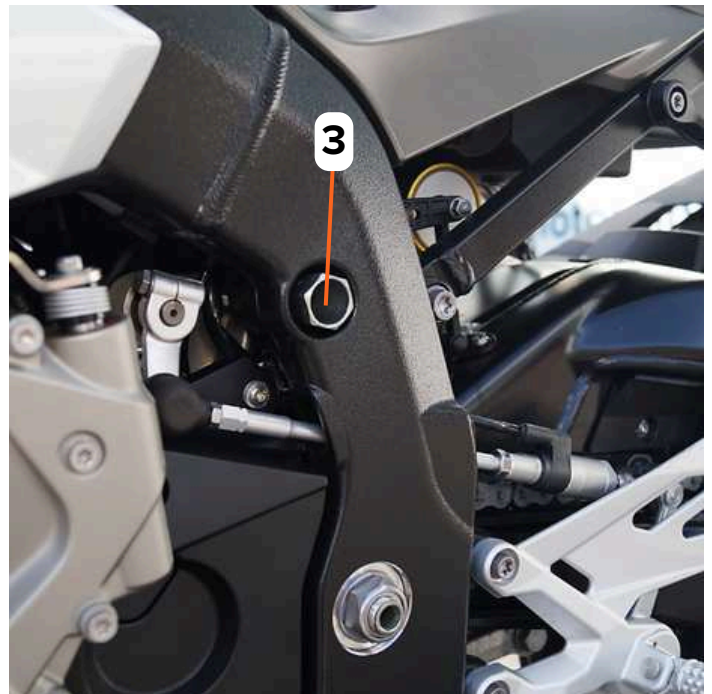

ConStands Power 304200



Yleistä

Kiitos, että olet ostanut ConStands-keskustelineen.

Lue seuraavat asennusohjeet huolellisesti. Motea GmbH ei ota vastuuta omaisuus- ja/tai henkilövahingoista, jotka johtuvat virheellisestä tai virheellisestä asennuksesta tai käytöstä. Tarkista oikea toiminta ennen jokaista käyttökertaa. Kiristä ruuvit tarvittaessa uudelleen.

Teknisten muutosten, painovirheiden ja virheiden varalta.

Informações gerais

Obrigado por ter adquirido um suporte central ConStands.

Por favor, leia atentamente as seguintes instruções de montagem. A Motea GmbH não se responsabiliza por danos materiais e/ou pessoais resultantes de uma instalação ou utilização incorrecta ou defeituosa. Verifique o funcionamento correto antes de cada utilização. Se necessário, volte a apertar os parafusos.

Sujeito a alterações técnicas, erros de impressão e erros.

Toimituksen laajuus / Âmbito de fornecimento

1. Sovitinlevy / Placa de adaptação (x 1)
2. Nostopultti / Parafuso de elevação (x1)
3. Rungon holkki / Casquilho da estrutura (x1)
4. Tappi kääntyvä akseli / Eixo oscilante do pino (x1)
5. Mutteri / Porca (x1)

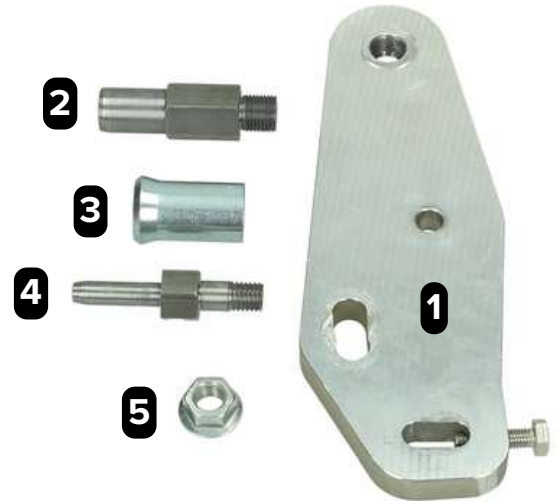

Sovitinlevyn kiinnitys / Fixação da placa adaptadora

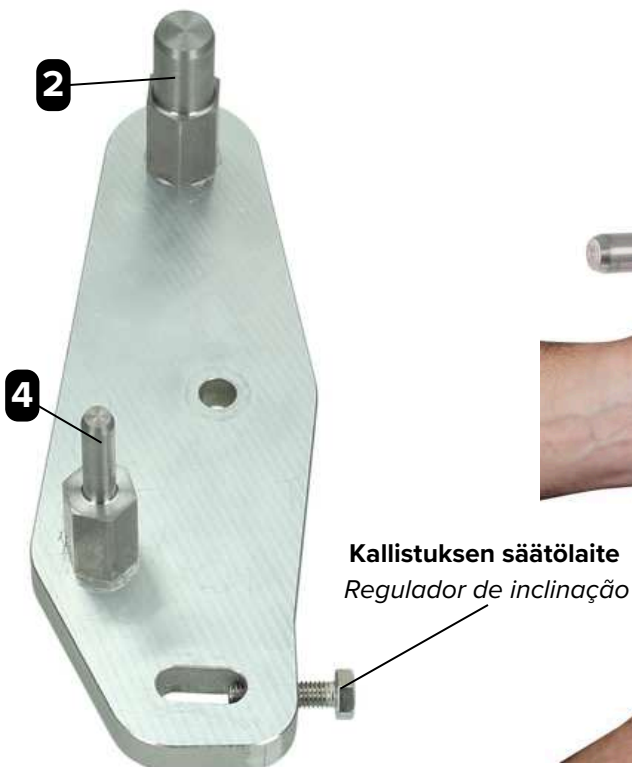

Kallistuksen säätölaite
Regulador de inclinação

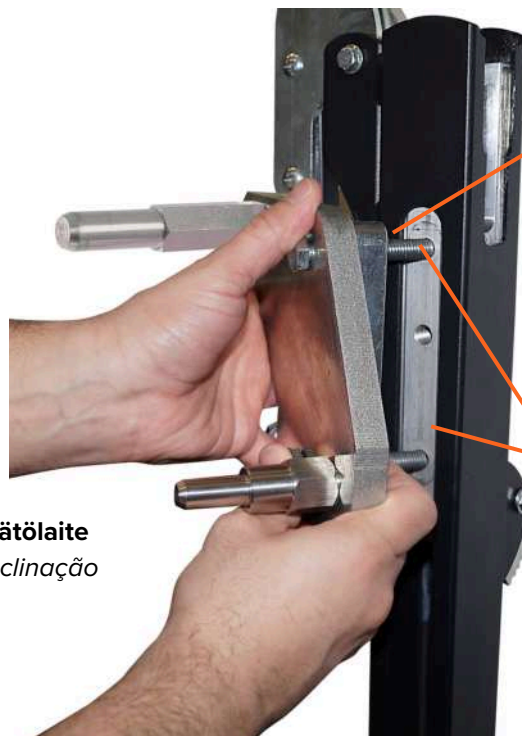

Etäisyyslevy / Placa de distância

303503

Tarvitaan vain Power Classic -laitteessa.
Apenas necessário para o Power Classic.

Ruuvit ja aluslevyt adapterilevyn kiinnittämiseksi keskitukeen sisältyvät keskitukin toimitukseen.

Os parafusos e as anilhas para fixar a placa adaptadora ao descanso central estão incluídos no volume de fornecimento do descanso central.

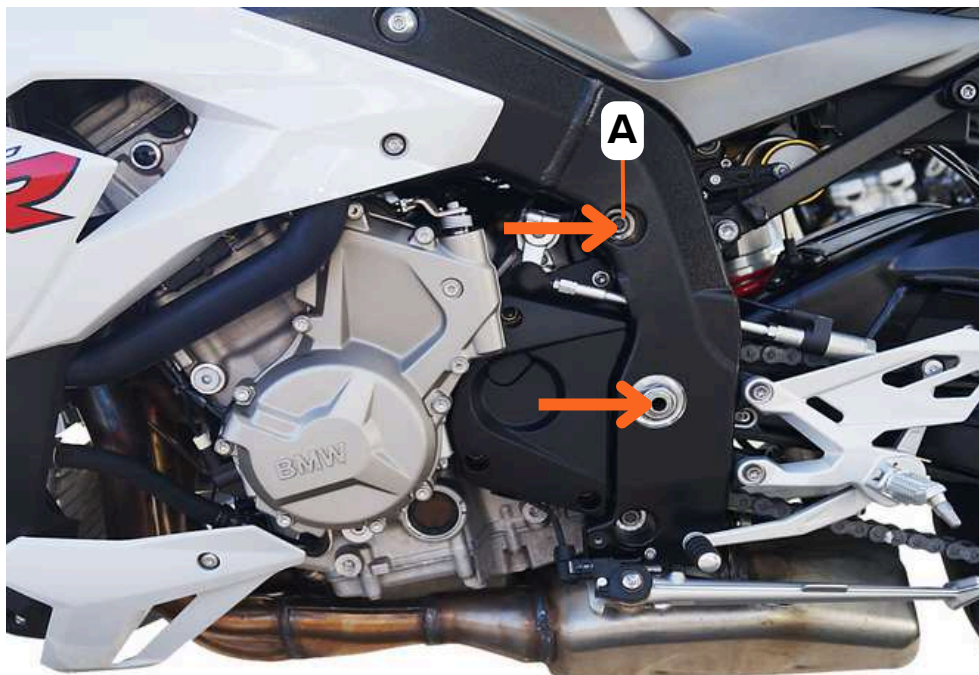

Kiinnitys ajoneuvoon / Montagem no veículo

1

Löysää moottorin pultti (A).

Desaperte o parafuso do motor (A).

2

Ruuvaa moottorin pultti (A) rungon holkkiin (3).

Aparafuse o parafuso do motor (A) ao casquilho da estrutura (3).

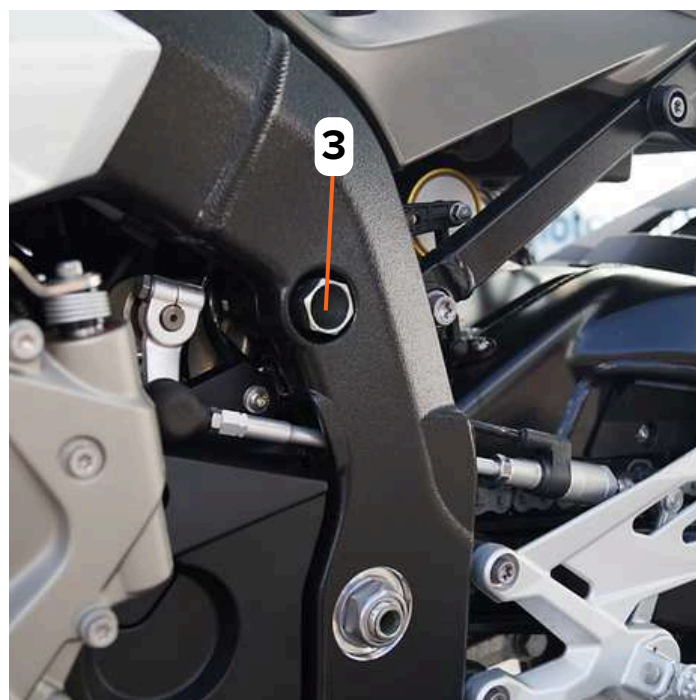
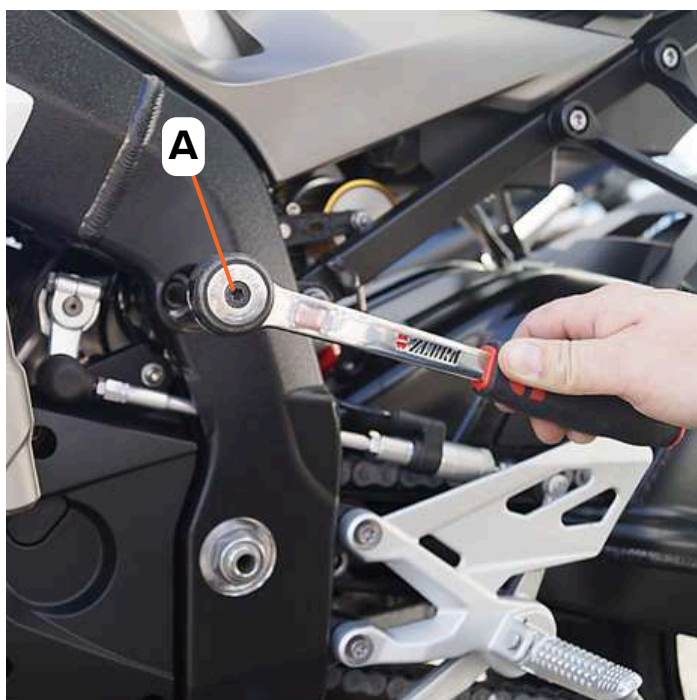

ConStands Power 304200



Obecné informace

Děkujeme, že jste si zakoupili centrální stojan ConStands.

Přečtěte si prosím pozorně následující montážní pokyny. Společnost Motea GmbH nepřebírá žádnou odpovědnost za škody na majetku a/nebo zranění osob v důsledku nesprávné nebo chybné instalace nebo používání. Před každým použitím zkontrolujte správnou funkci. V případě potřeby znovu utáhněte šrouby.

S výhradou technických změn, tiskových chyb a omylů.

Általános információk

Köszönjük, hogy ConStands központi állványt vásárolt.

Kérjük, figyelmesen olvassa el az alábbi szerelési útmutatót. A Motea GmbH nem vállal felelősséget a nem megfelelő vagy hibás telepítésből vagy használatból eredő anyagi és/vagy személyi károkért. Kérjük, minden használat előtt ellenőrizze a helyes működést. Szükség esetén húzza meg újra a csavarokat.

A technikai változások, nyomdai hibák és tévedések függvényében.

Rozsah dodávky / Szállítási terjedelem

1. **Adaptérová deska / Adapterlemez (x 1)**
2. **Zvedací šroub / Emelőcsavar (x1)**
3. **Pouzdro rámu / Keret persely (x1)**
4. **Kyvná hřídel čepu / Tüske lengőtengely (x1)**
5. **Matice / Anyát (x1)**



Montáž adaptérové desky / Az adapterlemez rögzítése



Nastavovač sklonu
Dőlésszögbeállító



Vzdálenostní deska /
Távolsági lemez

303503

Vyžaduje se pouze u modelu Power Classic.

Csak a Power Classic esetében szükséges.



Šrouby a podložky pro upevnění adaptérové desky ke středovému stojanu jsou součástí dodávky středového stojanu.

Az adapterlemez középállványhoz való rögzítéséhez szükséges csavarokat és alátéteket a középállvány szállítási terjedelembe tartalmazza.

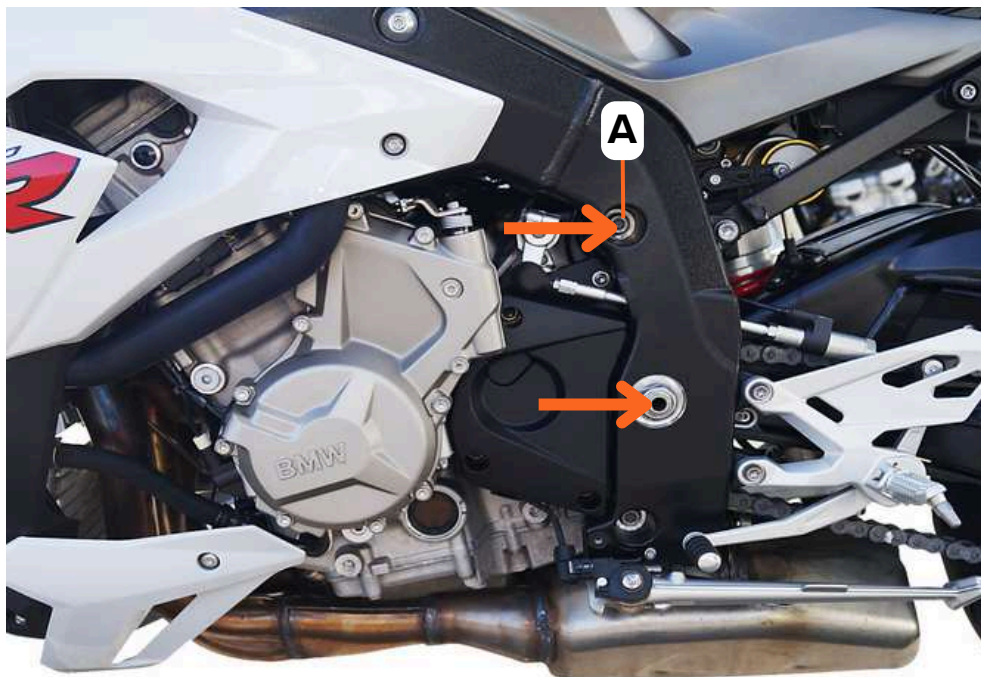

Montáž u vozidla / Szerelés a járművön

1

Povolte šroub motoru (A).

Lazítsa meg a motorcsavart (A).

2

Příšroubujte šroub motoru (A) k pouzdru rámu (3).

Csavarozza a motorcsavart (A) a vázperselyhez (3).

