

BMW R18 '20-

M O U N T I N G I N S T R U C T I O N S

REF. 21048

SEMIFAIRING BATWING SML TOURING MODEL



TORX
T27
T40

ALLEN
Nº 3



En las revisiones del vehículo es conveniente efectuar también el mantenimiento de apriete de toda la tornillería de semicarenado, especialmente los tornillos que están fijados al vehículo. Gracias por su atención.
It would be convenient to retighten the semifairing screws, specially the ones that are fixed to the motorcycle, whenever you maintain the vehicle. Thanks for your attention.

ID	PIEZA/PART	DESCRIPCIÓN	DESCRIPTION	QTY	REF
1		Semicarenado batwing SML	Batwing SML semifairing		10897N
2		Cúpula TOURING	TOURING screen	1	10900W/H
3		Soporte Izquierdo (L)	Left support (L)	1	SOP2P3L-BTM0023
4		Soporte derecho (R)	Right support (R)	1	SOP2P3R-BTM0023
5		Casquillo Ø13 x Ø8,5 x 6mm	Ø13 x Ø8,5 x 6mm Arrowhead	2	CASQUI-----776
6		Tornillo M8x45 ISO7380 CABEZA TX (INOX)	M8x45 ISO 7380 TX screw (INOX)	2	TORNI-I7380-870
7		Arandela nylon M5x1	M5x1 nylon washer	4	ARNV0000000245
8		Silentblock M5	M5 silentblock	4	SILENBTM5-046/1
9		Tornillo Allen M5x16 Ø11 ISO 7380	M5x16 Ø11 ISO 7380 Allen screw	4	TORNI-I7380-493
10		Tapón tornillo M5 ISO 7380	M5 ISO 7380 screw cap	4	TAPON-----85
11		Tornillo Allen M4x12 ISO7380	M4x12 ISO 7380 Allen screw	3	TORNI-I7380-800
12		Arandela nylon M4x0,5	M4x0,5 nylon washer	6	ARNV0000000311
13		Tuerca autoblocante M4	M4 nut	3	TUERCAE985-0290
14		Tapón tuerca M4	M4 cap nut	3	TAPON-----91

BMW R18 '20-

INSTRUCCIONES DE MONTAJE - MOUNTING INSTRUCTIONS - MONTAGEANLEITUNG

1

DISASSEMBLY
DESMONTAJE

Se muestra el montaje del lado izquierdo a modo de ejemplo, realizar los mismos pasos para el montaje del lado derecho.
The left side assembly is shown as an example, so the same steps can be performed for the right side assembly.

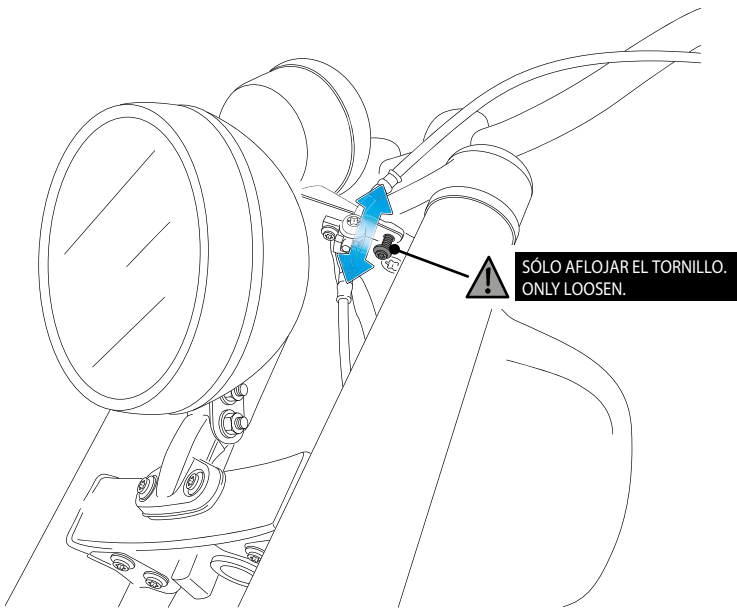

2

DISASSEMBLY
DESMONTAJE

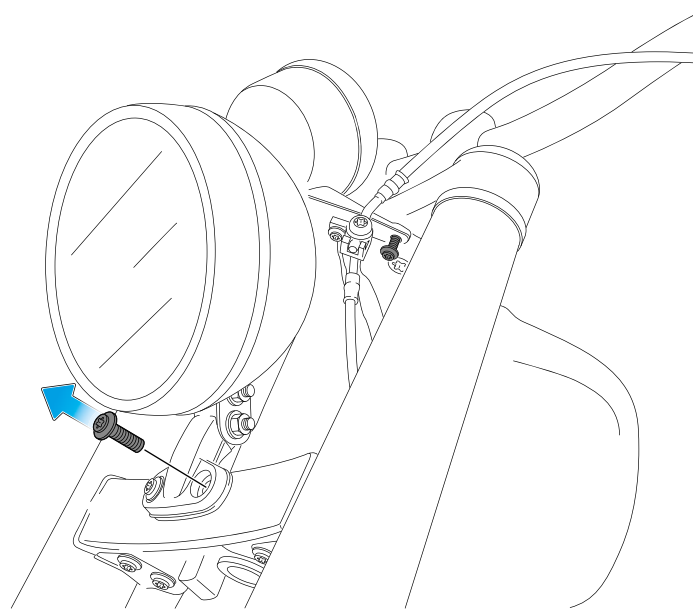

3

ASSEMBLY
MONTAJE

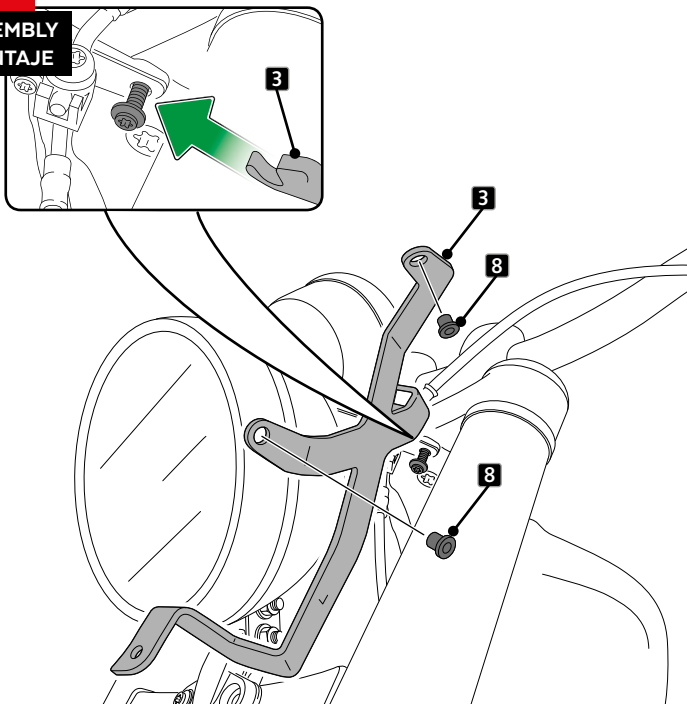

4

ASSEMBLY
MONTAJE

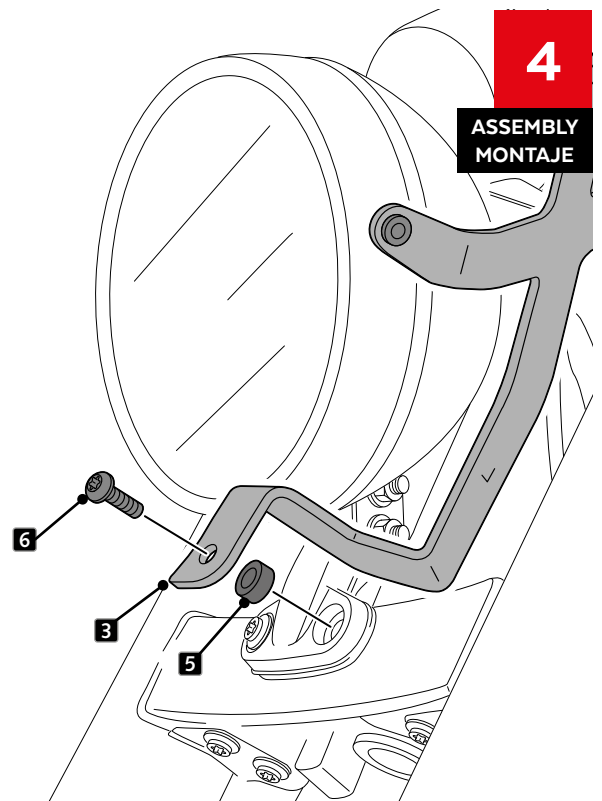

BMW R18 '20-

INSTRUCCIONES DE MONTAJE - MOUNTING INSTRUCTIONS - MONTAGEANLEITUNG

5

ASSEMBLY
MONTAJE

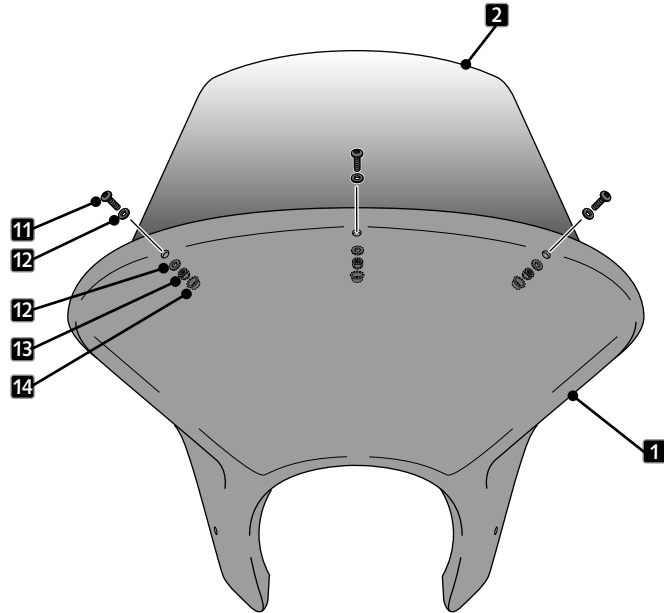

6

ASSEMBLY
MONTAJE

